

# LVP609 Series

## 4K 60Hz LED Video processor

### User Manual



## Contents

<b>Chapter 1: Safety precautions.....</b>	<b>3</b>
<b>Chapter 2: Packing list.....</b>	<b>4</b>
<b>Chapter 3: Hardware connection.....</b>	<b>5</b>
3.1 Rear panel signal port picture.....	5
3.2 Port description.....	5
3.3 Hardware connection diagram.....	7
3.4 Technical specification.....	7
3.5 Installation dimension.....	9
<b>Chapter 4 : Frontal panel button description.....</b>	<b>10</b>
4.1 Frontal panel button sketch map.....	10
<b>Chapter 5: User basic operation instruction.....</b>	<b>13</b>
5.1 Input signal selection.....	13
5.2 Output card operation.....	15
5.3 Other function operation.....	15
<b>Chapter 6 : User setup menu instruction.....</b>	<b>18</b>
6.1 Input card setup.....	18
6.2 Output card setup.....	20
6.3 Sync & Backup Setup.....	23
6.4 System setup.....	26
<b>Chapter 7: Mode instruction.....</b>	<b>30</b>
Appendix: Manual modification record.....	31

## Chapter 1: Safety precautions



### **Danger !**

There is high voltage in the processor, to prevent any unexpected hazard, unless you are a maintenance personnel, please do not open the cover of the device.



### **Warning !**

1. This device shall not encounter water sprinkle or splash, please do not place anything containing water on this device.
2. To prevent fire, keep this device far from any fire source.
3. If this device gives out any strange noise, smoke or smell, please immediately unplug the power cord from receptacle, and contact local dealer.
4. Please do not plug or unplug DVI signal cable if the device is powered on.



### **Caution !**

1. Please thoroughly read this manual before using this device, and keep it safe.
2. In the event of lighting or when you are not going to use the device for a long time, please pull the power plug out of receptacle.
3. Nobody other than professional technicians can operate the device, unless they have been appropriately trained or under guidance of technicians.
4. To prevent equipment damage or electric shock, please don't fill in anything in the vent of the device.
5. Do not place the device near any water source or anywhere damp.
6. Do not place the device near any radiator or anywhere under high temperature.
7. To prevent rupture or damage of power cords, please handle and keep them properly.
8. Please immediately unplug power cord and have the device repaired, when
  - ① Liquid splashes to the device.
  - ② The device is dropped down or cabinet is damaged.
  - ③ Obvious malpractice is found or performance degrades.

## Chapter 2 : Packing list

Please unpack the product with care, and then check whether all the following items are included in the package. If anything is found missing, please contact the dealer.

### Standard accessories

The accessories supplied with this product may differ from the following pictures, but they are applicable for the regions where you live ( LED sending card is optional accessory )

		
1.5m power cable x1	1.5m DVI cable x1	0.5m DVI cable ( depends on DVI output quantity )
		
1.5m HDMI cable x1	1.5m DP cable x1	<b>VGA to VGA+RCA</b> cable x1
		
1.5m RS232-RJ45 convert cable X1	Products data U disk X1	Quick operation instruction X1

## Chapter 3 : Hardware connection

### 3.1 Rear panel signal port picture

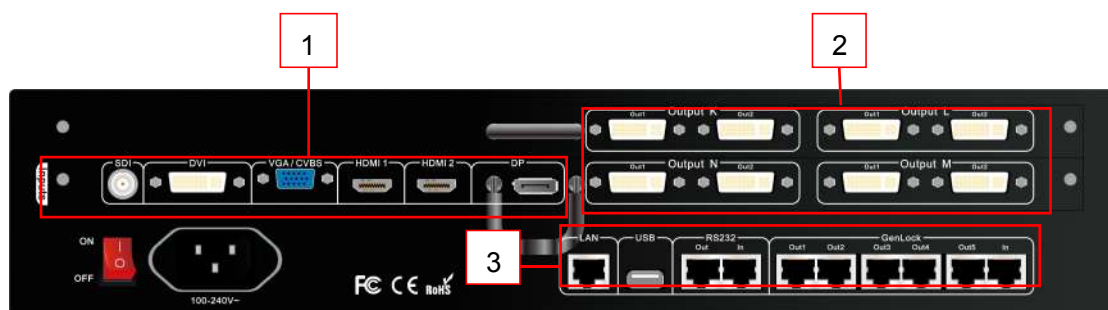

Picture 3-1 Rear panel signal port picture

- ① Video input port    ② Video output port    ③ Communication port

### 3.2 Port description

#### 3.2.1 Video signal input

LVP609 supports 6 channels of video signal input as the table below:

Ports	Description
<b>CVBS</b>	1 channel of PAL / NTSC system composite video input
<b>VGA</b>	1 channel of PC analog signal input
<b>DVI</b>	1 channel of DVI digital signal input ( compatible with HDMI1.3 )
<b>SDI</b>	1 channel of SDI digital serial signal input ( compatible with HD-SDI / 3G-SDI )
<b>HDMI1/HDMI2</b>	1 channel of HDMI 2.0 digital signal input
<b>DP</b>	1 channel of DP1.2 digital signal input

### 3.2.1 Video signal input

LVP609 can assemble maximum 4 output cards, the serial number are K L M N. Every output card can outputs 2 channels of DVI image signal, output port as the table below:

Ports	Description
<b>Out1, Out2</b>	2 channels of DVI output port, used to connect LED sending card or monitor

### 3.2.3 Communication port

Ports	Description
<b>LAN</b>	Local area network TCP/IP network control port
<b>USB</b>	USB communication port
<b>RS232 In</b>	Serial port communication port, RS232 electrical level, connect the RS232 interface of computer, for using PC software control processor
<b>RS232 Out</b>	Serial port communication cascading output, RS232 electrical level, when through single PC control several processors to use
<b>GenLock In / Out</b>	Synchronous lock frame signal input and output

### 3.3 Hardware connection diagram

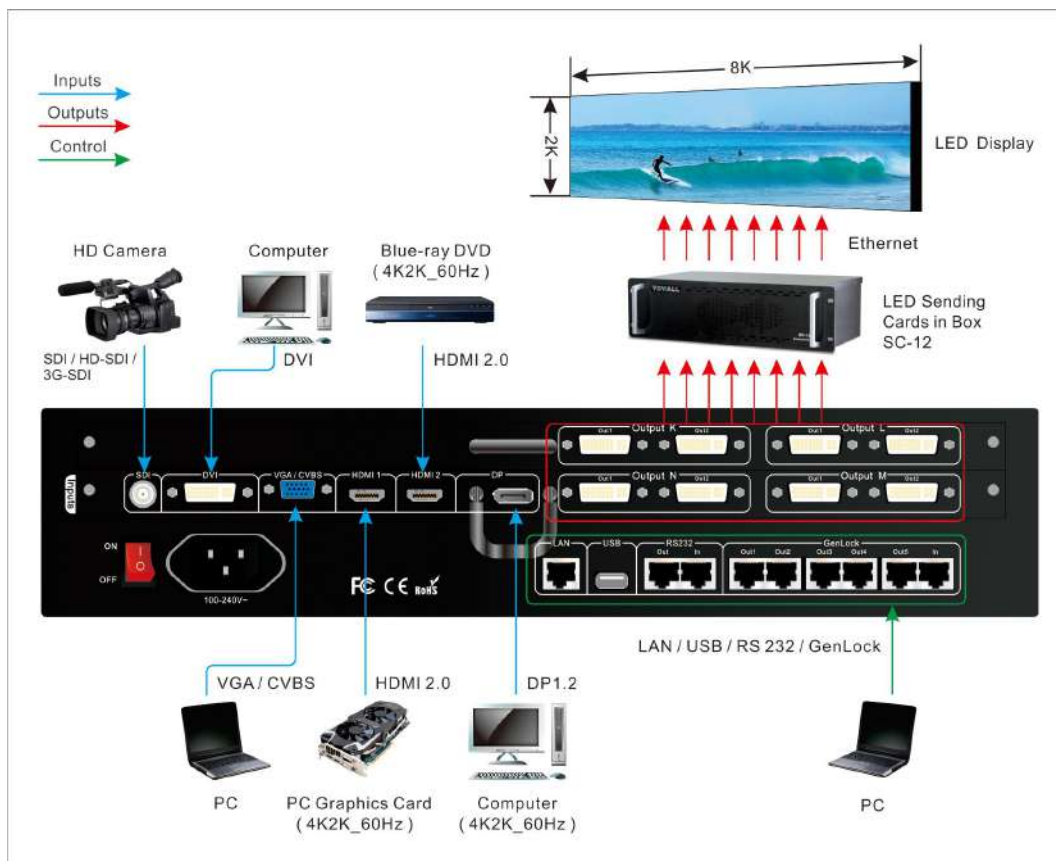

Picture 3-3 hardware connection diagram

### 3.4 Technical specification

Input signal index	
Quantity / type	1×CVBS 1×VGA ( RGBHV ) 1×DVI ( VESA/CEA-861 ) 1×SDI ( HD-SDI/3G-SDI ) 2×HDMI 2.0 ( VESA/CEA-861 ) 1×DP1.2 ( VESA )
Composite video system	PAL/NTSC
Composite Video Amplitude / Impedance	1V ( p_p ) / 75Ω
VGA format	PC ( VESA )      ≤1920×1200_60Hz

VGA Amplitude / Impedance	R, G, B = 0.7 V ( p_p ) / 75Ω	
DVI format	PC ( VESA )	≤1920×1200_60Hz
	HDMI1.3 ( CEA-861 )	≤1080p_60Hz
SDI format	SMPTE259M-C SMPTE 292M SMPTE 274M/296M SMPTE 424M/425M	480i_60Hz 576i_50Hz 720p、1080i、1080p
HDMI 2.0 ( HDCP 2.2 )	PC ( VESA )	≤1920×1200_60Hz
	HDMI2.0 ( CEA-861 )	≤3840x2160_60Hz
DP1.2 ( HDCP 2.2 )	PC ( VESA )	≤3840x2160_60Hz
Input port	CVBS : BNC VGA : 15pin D_Sub(female) DVI : 24+1 DVI_D SDI : BNC/ 75Ω HDMI 2.0: HDMI A mode DP1.2: Display port1.2	
Output signal index		
Quantity / type	8×DVI	
DVI format	1920×1080p_60Hz	
Output port	DVI OUT : 24+5 DVI_I	
Sync port	GenLock	
Other		
Control port	RS232/USB/LAN	
Input voltage	100-240VAC 50/60Hz	
Overall power consumption	≤100W	
Environment temperature	0-45 °C	
Environment humidity	15-85%	
Product size	483( Length ) x 338( Width ) x 94( Height )mm	
Packing size	540( Length ) x 400( Width ) x 180( Height )mm	
Weight	G.W. : 9Kg, N.W. : 5Kg	



### 3.5 Installation dimension

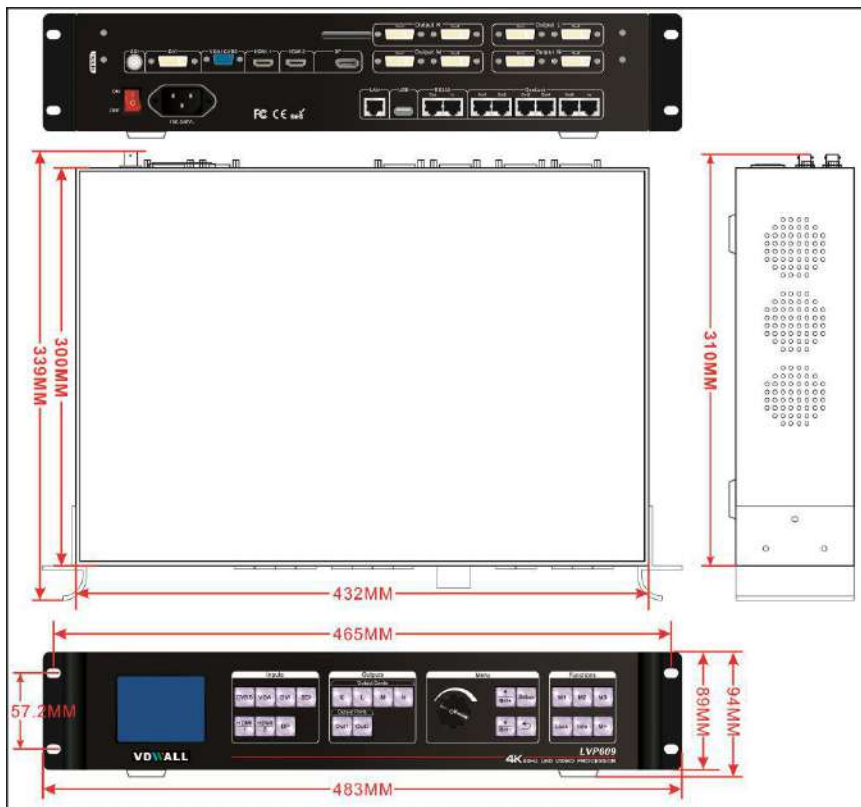

Picture 3-5a installation dimension drawing

### RS232 connection wires, wires order

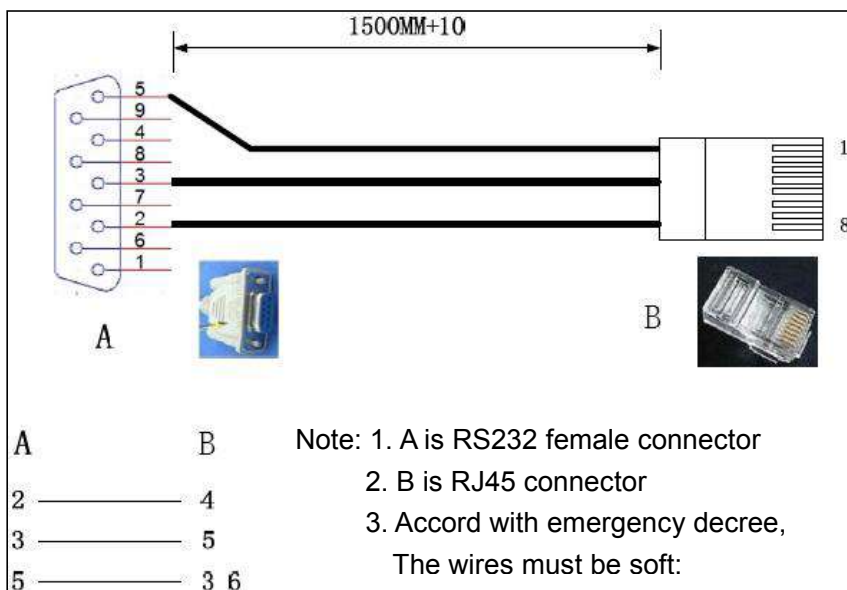

Picture 3-5b RS232 connection wires, wires order

## Chapter 4 : Frontal panel button description

### 4.1 Frontal panel button sketch map

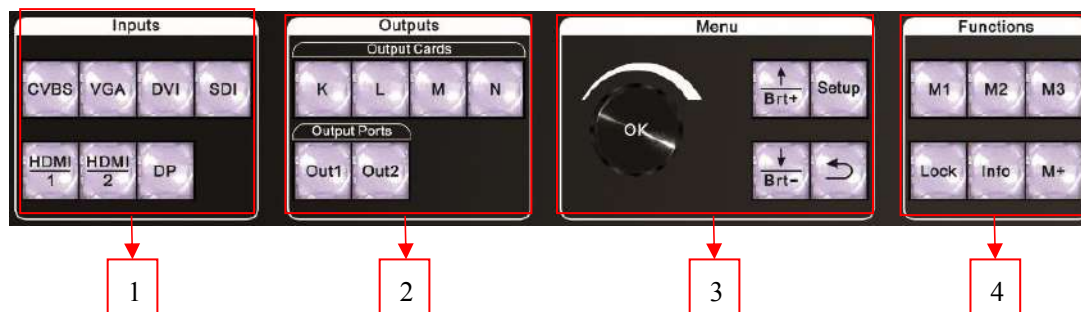

Picture 4-1 frontal Panel button sketch map

- ① Input signal selection button
- ② Output card function button
- ③ Setup button
- ④ Other function button

#### 4.1.1 Input signal source selection button

Input card signal source selection buttons, when select some signal source, the green indicator light on relative button lit up. If the input port inputted valid signal, the indicator lit up normally, or it will flicker.



**Note:** press  button twice processor will adjust VGA signal automatically.

#### 4.1.2 Output card selection button

When select some output card, the red indicator light on relative button lit up, this moment you can do relative operation to the output card.



### 4.1.3 Output card port selection button

Output card selection button, when select some output port, the green indicator light on relative button lit up normally, this moment you can do relative operation to the output image.



### 4.1.4 Setup buttons

Setup button: set processor function parameters.



Press to enter setup menu



Press to select upper or down setup option



Rotate **Knob** to adjust numerical value or select parameter





Press **Knob** / **OK** button, to save parameter



Used for return to last menu

### 4.1.5. Information display

Information display (**Info**), when device is working and operation status, press (**Info** button) the LCD of processor displays current setup and information. Press  or  can check the last or next option, press  button to exit the interface.

#### 4.1.6. Display mode buttons ( **M1** , **M2** , **M3** , **M+** ) :

Press display mode button to call the display mode, meantime the indicator light on the button lit up normally.

Every set of display mode in the device include the input and output parameter of output image.

#### 4.1.7 Lock button

Lock button ( **Lock** ) , buttons lock function button, when lock is open the red indicator light on the button lit up, except **Lock** , another buttons are not available, press **Lock** button three times continually to unlock, the red indicator light on the button is closed.

## Chapter 5: User basic operation instruction

After system power on, LVP609 will detect the quantity, location and configuration information of card automatically, different configuration, the display interface on LCD is different, the relative instruction below is under full configuration (4 output cards) and system start under default menu.

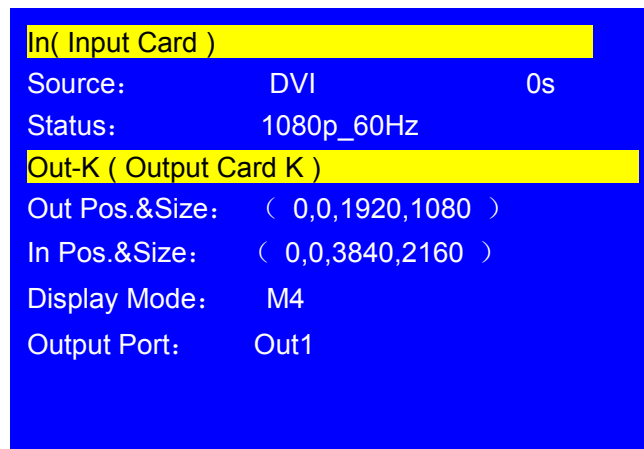

Picture 5-0 LCD interface : System default operation interface

### 5.1 Input signal selection

In user operation interface, the operation content of input card includes input signal selection, signal switch time setup and VGA input automatic adjustment.

#### 5.1.1 Input signal selection

Press input signal source button ( **CVBS**, **VGA**, **DVI**, **SDI**, **HDMI1**, **HDMI2**, **DP** ), when select some signal source, the green indicator light on relative button lit up. If the input signal to the input port is valid, the indicator light lit up normally; or the indicator light flicker.

## 5.1.2 Signal switching time setup

Switching between input signal, can set 0s seamless switching or 1s, 2s, 3s fade in fade out switching, you can configure these parameter in user menu, press Setup button to enter user setup menu select 1.Input Card Setup—2.Advanced Setup—1.Fade Time to enter the configuration menu.

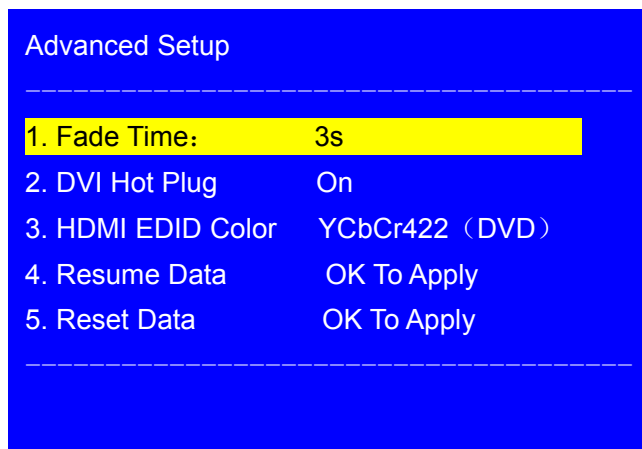

Picture 5-1a LCD interface : Fade in fade out time setup

## 5.1.3 VGA input signal automatic adjustment

When input card signal source is valid VGA input, press **VGA** button to enter VGA automatic adjustment menu, press **VGA** button again to adjust VGA automatically, press  button to exit menu.

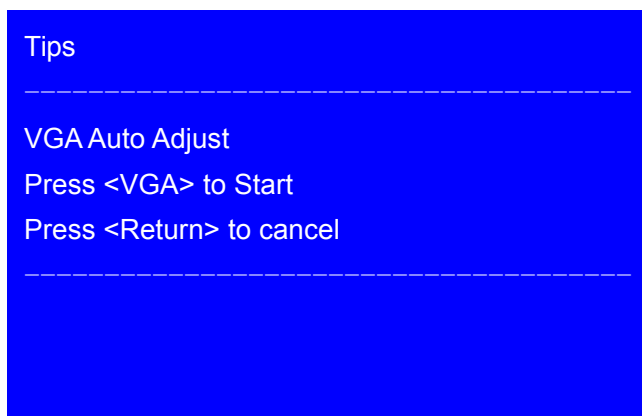

Picture 5-1b LCD interface : VGA automatic adjustment confirmation menu

## 5.2 Output card operation

In user operation interface, the operation content of output card includes **check output port information and display mode setup**.

### 5.2.1 Check output port parameter

Firstly press output card button ( **K**, **L**, **M**, **N** ) to select output card, then press output port button ( **Out1**, **Out 2** ) to select output port, this moment the LCD on front panel displays the input and output parameters of current port.

### 5.2.2 Output card display mode setup

Display mode from 1 to 16, total 16 sets, the first 3 modes can press **M1**, **M2**, **M3** to call, meantime the indicator light on the button lit up; For Display Mode 4 to 16 need to press **M+** to enter mode selection setup and rotate knob to choose, meanwhile **M+** lit up. Then enter **2.Output Card Setup** to set input and output parameter, and to set display effect of corresponding display mode.

## 5.3 Other function operation

Except the relative operation of input and output card, also have **button lock**, **check system information** relative operation etc.

### 5.3.1 Button lock

To prevent mistake operation press **Lock** button to open lock, other buttons will be lock. When buttons under lock status, to prevent conflict between remote operation and button operation only LAN, RS232 and USB communication are available.

When button is lock status, press **Lock** button 3 times continually to exit.



Picture 5-3a LCD interface : Button lock

### 5.3.2 Check system information ( **Info** )

Press **Info** button to enter **system information** menu, press **↑,↓** button to check, press **↶** button to exit, **system information** menu as below:

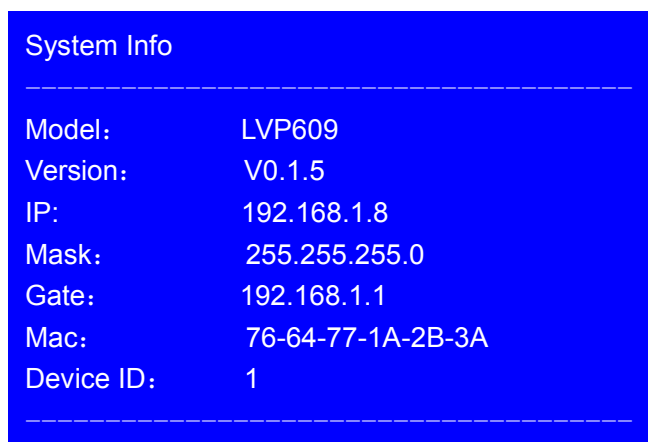

Picture 5-3b LCD interface : System information





Picture 5-3c LCD interface : System information

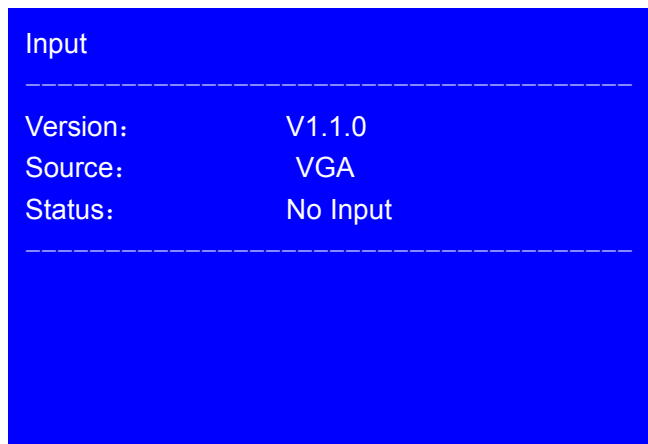

Picture 5-3d LCD interface : System information

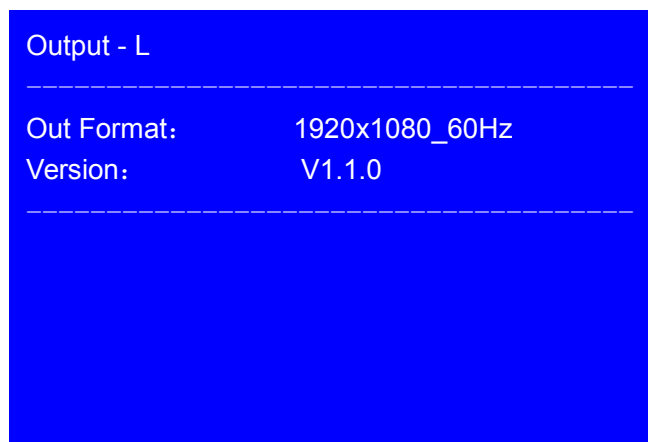



Picture 5-3e LCD interface : System information

## Chapter 6 : User setup menu instruction

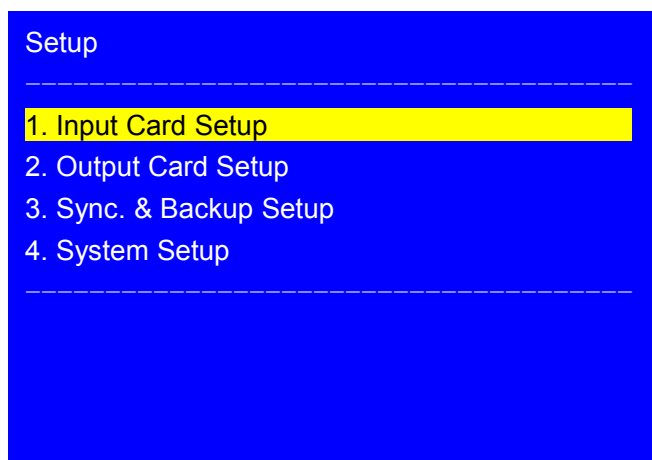
User setup menu is about whole processor setup, total divide to be 3 modules, respectively are **input card setup, output card setup, sync&backup setup and system setup.**



Picture 6 LCD interface : Setup

After system start, press **Setup** button to enter user setup menu, under the menu through press  button to select relative setup menu option, press knob button (OK button) to enter, press  button to return to last menu. The particular function introduction about every menu as below:

### 6.1 Input card setup

After system starting up, press **Setup** button to enter user setup menu, in the menu through press  button to select **Input Card Setup**, press knob (**OK** button) to enter the setup menu as below. In the menu can configure input card parameters.

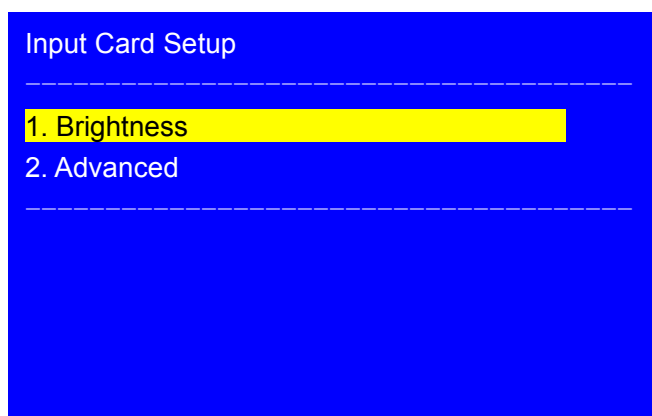

Picture 6-1a LCD interface : Input card setup

### 6.1.1 Brightness

1. **Brightness** menu is used to set the brightness parameter. Rotate **knob** to change current parameter, press **knob** ( **OK** button ) to save parameter, 2. **Reset** option is used to reset brightness parameter.

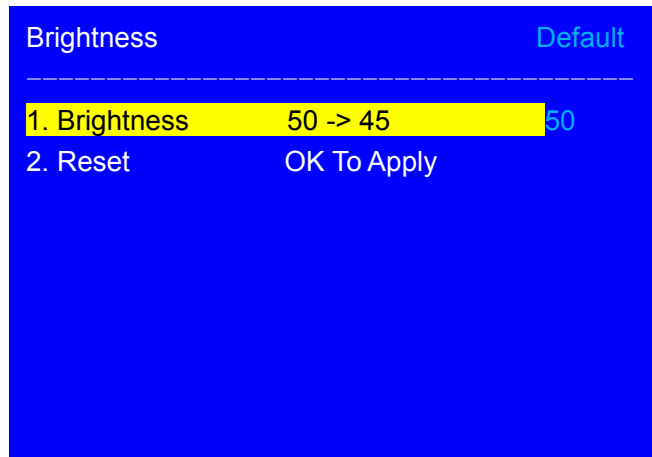

Picture 6-1b LCD interface : Image quality setup



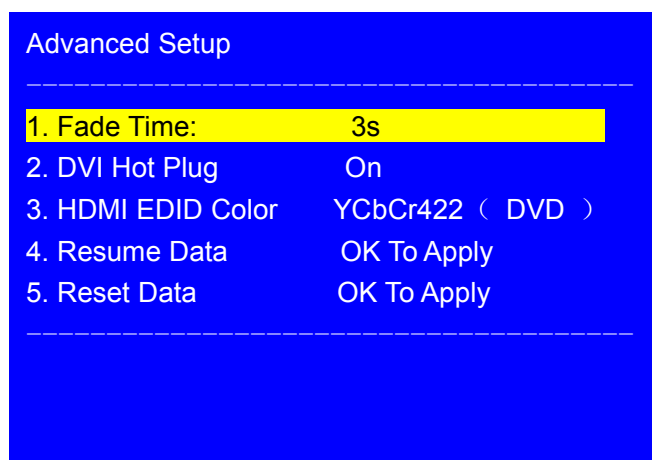

### 6.1.2 Input card advanced setup







Picture 6-1c LCD interface : Input card advanced setup

Input card advanced setup menu include **Fade Time**, **DVI hot plug**, **HDMI EDID Color**, **Resume data** and **Reset Data** options, the particular function as the table below.

Menu	Function description
1. Fade Time	set fade in fade out switching time between input signal
2. DVI Hot plug	DVI input port hot plug signal switch setup, it is applied for minority PC system, to prevent the problem when switch DVI signal cause the playing video changed to be desktop background.
3. HDMI EDID color	Set HDMI EDID data as YCbCr422 or RGB format to adapt some 4K signal source, which discern incompatible EDID data appearing color mistake problem
4. Resume data	Recover system data to input card, normally after replacing new input card we need to recover the system data
5. Reset data	It is used to delete the user data in input card, to recover the data be default value, cautious to use!

Setup method: press ,  button to select relative setup option, the frontal three options according to the reminder of menu press  button, then after appearing confirmation menu press  button continually.

## 6.2 Output card setup

After system starting up, press  button to enter user setup menu, in the menu through press ,  button to select 2. Output Card Setup, press Knob ( button) to enter the menu as below. In the menu can set output card parameter.

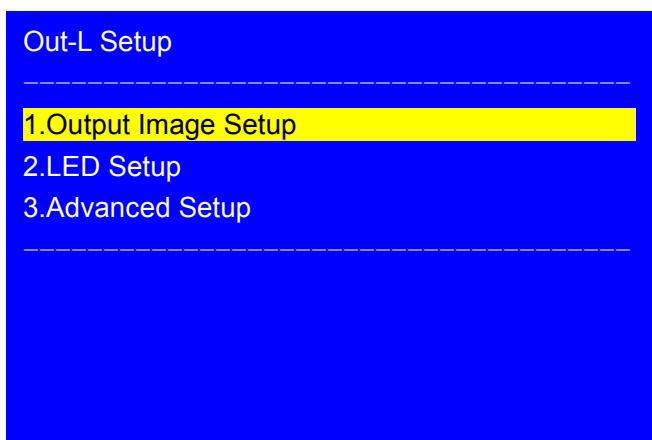

Picture 6-2a LCD interface : Output card setup

## 6.2.1 Output image setup

Output Image Setup	Out-K / M1 / Out2	
1. In Width	1920 -> 956	3840
2. In H_Start	360	0
3. In Height	1080	2160
4. In V_Start	0	0
5. Output Width	1912	1920
6. Output H_Start	0	0
7. Output Height	1079	1080
8. Output V_Start	0	0

Picture 6-2b LCD interface : Output image setup

Setup menu of output image used to set the input and output parameter of output image. In the menu press display mode button ( for example **M1** , **M2** ) to select current display mode, press output card button( **K** , **L** , **M** , **N** ) to select output card, press **↑**,**↓** button to select relative menu option, rotate **knob** to change current parameter, press **knob** ( **OK** button ) to save parameter.

## 6.2.2 LED setup

LED Setup	Out-K / M1 / Out2	
1. LED Total Width	3840	
2. LED Total Height	2160	
3. Unit Width	1920	
4. Unit Height	1080	
5. Unit H_Start	0	
6. Unit V_Start	0	
7. Auto Calculation	OK To Apply	

Picture 6-2c LCD interface : Input image setup

LED setup menu used to import LED splicing screen parameter for quick splicing. The operation method of quick splicing as below:

- ① In 1-2 option import the total width and height of the LED needed to splice;
- ② In 3-6 option import the LED screen actual size and location which the output port drives;
- ③ In 7.Auto calculation option press **OK** button, then the current parameters in input image setup and input image setup menu update as automatic calculation parameter, meantime the right side of every setup option displays calculated reference value.

### 6.2.3. Advanced setup

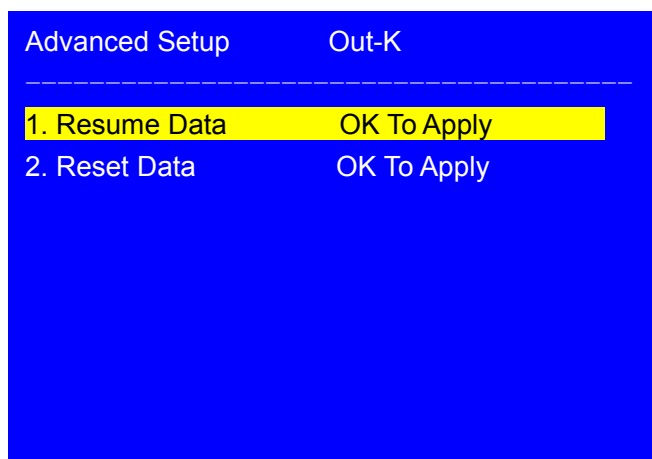

Picture 6-2d LCD interface : Output card advanced setup

1.Data Resume and 2.Reset Data two setup options, the particular function instruction as the table below.

Menu	Function instruction
1.Resume Data	Recover system data to the output card, generally after replacing new output card we need to do this.
2. Reset Data	It is used to delete user setup of output card, recover the parameter of current output resolution and application mode to be default status, careful to use!

Setup method: Press output card button ( **K** , **L** , **M** , **N** ) to select output card, press **↑,↓** button to select relative setup menu option, press **OK** button, then in the reminder menu of **data will reset**, press **OK** button again.

## 6.3 Sync & Backup Setup

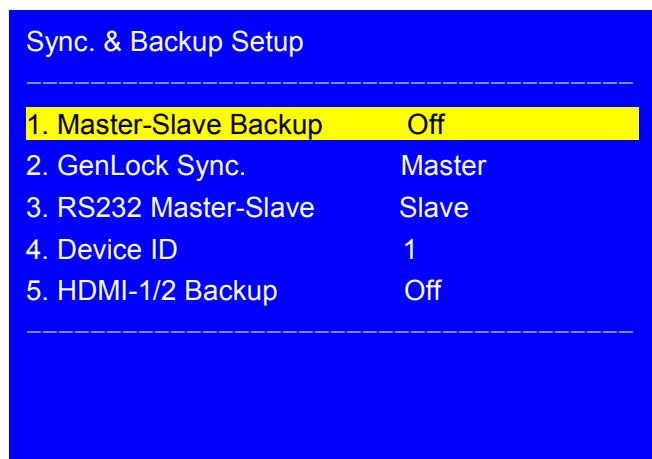

Sync. & Backup Setup	
1. Master-Slave Backup	Off
2. GenLock Sync.	Master
3. RS232 Master-Slave	Slave
4. Device ID	1
5. HDMI-1/2 Backup	Off

Picture 6-3a LCD interface: Sync. & Backup Setup

The Sync. & Backup menu is used to turn on **Master-Slave Backup**, **GenLock Sync Splicing**, and **Single-unit HDMI-1/2 Backup** applications.

After the system starts, press **Setup** to enter the user settings menu, press **↑,↓** button to select **3. Sync. & Backup** settings, press **OK** to enter the menu above. The function description of each setting item is shown in the following table. The parameter setting method will be described separately for these three functional applications.

Menu	Function description
Master-Slave Backup	"On" means that the dual processor backup function is turned on and "off" means that the function is turned off
GenLock Sync.	"Master" device uses the internal synchronization signal, "Slave" device priority to use external GenLock input signal to lock the frame, if no GenLock input, then automatically switch to the internal synchronization signal
RS232 Master-Slave	"Master" device as the master device, "Slave" device is not the master device.
Device ID	For multi-unit cascade numbering
HDMI-1/2 Backup	"On":when HDMI1 signal lose, processor will switch to HDMI2 automatically,"Off"means turn off this function.

### 6.3.1. Master-Slave Backup

**Master-Slave Backup**, Means using the GenLock synchronous lock frame function and RS232 communication protocol to set up full hot backup system composed by 2 LVP609. The system can achieve whole hot backup from the signal source, processor, sending cards, receiver cards and a variety of connection lines failure to ensure stability and reliability of LED display system for important occasions and moments is truly stable and reliable. The following is the system topology and backup mode.

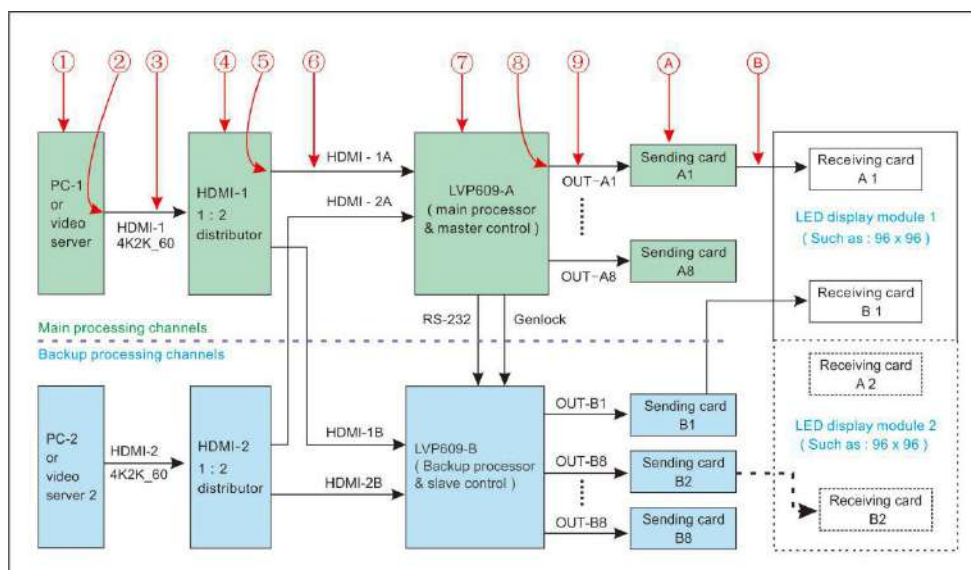

Picture 6-3a Full hot backup system topology



Malfunction number	Malfunction description	Backup way
1,2,3,4	HDMI-1: 2 video outputs HDMI-1A and HDMI-1B no signal	① LVP609-A switch to HDMI-2A Meanwhile: ② LVP609-B switch to HDMI-2B
5,6	HDMI-1A no signal, while HDMI-1B signal normal	LVP609-A turn off output, all LED display modules switch to receiving card B1 to B8 to drive.
7	LVP609-A: OUT-A1 to OUT-A8 all no DVI signal output	All LED display modules switch to receiving card B1 to B8 to drive.
8,9,A,B	Receiving card A1 to A8: One or several no signal input	LED display modules switch one or several receiving cards from B1 to B8 to drive.

#### Full hot backup way

After the devices properly connected, you can set the master and slave processors in the following table to enable the hot backup function.

Menu	Parameters Setting	
	Main Processor	Backup Processor
Master-Slave Backup	On	On
GenLock Sync.	Master	Slave
RS232 Master-Slave	Master	Slave
Device ID	1	2
HDMI-1/2 Backup	Off	Off

### 6.3.2 Enable multi-unit sync splicing without enabling backup

For some large resolution LED display, you can cascade through multiple processors to achieve synchronous splicing, this application does not require backup function. The parameter settings can refer to the following table:

Menu	Parameters Setting	
	Master Processor	Salve Processor
Master-Slave Backup	Off	Off
GenLock Sync.	Master	Slave
RS232 Master-Slave	Slave	Slave
Device ID	1	1
HDMI-1/2 Backup	Off	Off

### 6.3.3 Enable HDMI1 / 2 hot backup function

Single unit HDMI1 / 2 hot backup function, refers when the current processor HDMI1 signal is lost, the processor immediately switch to HDMI2 signal to avoid output image interruption because of signal source problem. The parameters are set as follows:

Menu	Parameter Setting
Master-Slave Backup	Off
GenLock Sync.	Master
RS232 Master-Slave	Slave
Device ID	1
HDMI-1/2 Backup	On

## 6.4 System setup

After system starting up, press **Setup** to enter user setup menu, in the menu trough press **↑,↓** button to select **3.system setup**, press **OK** button to enter the menu as below. In the menu can set communication parameter and output resolution and application mode of LVP609.

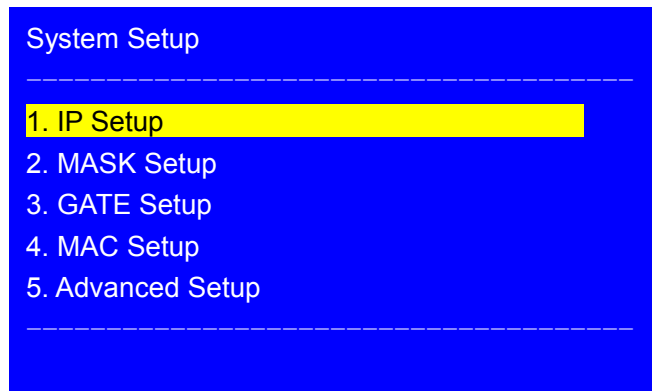

Picture 6-4a LCD interface : System setup

### 6.4.1 Communication setup

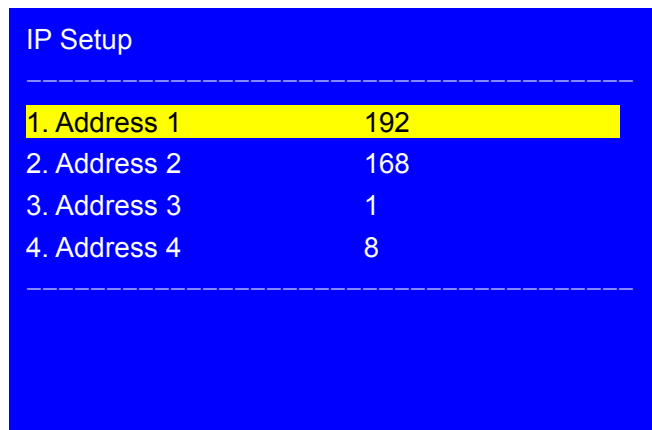

Picture 6-4b LCD interface : IP setup

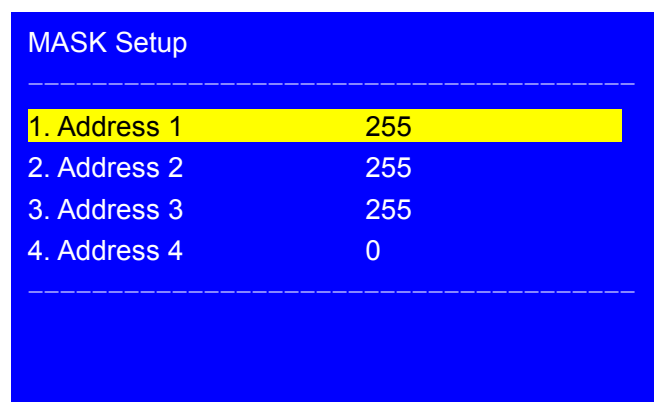

Picture 6-4c LCD interface : MASK Setup

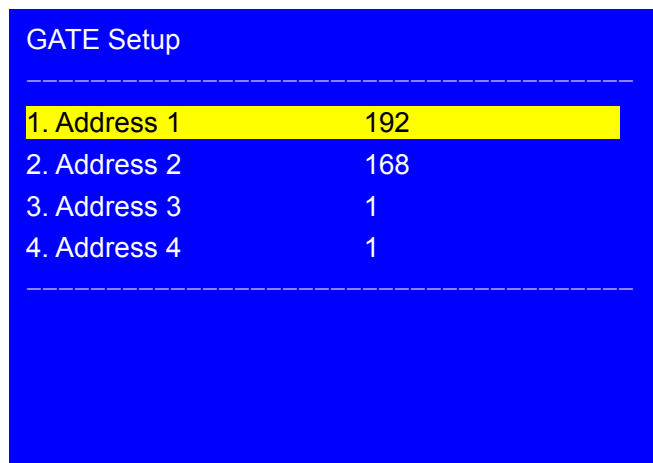



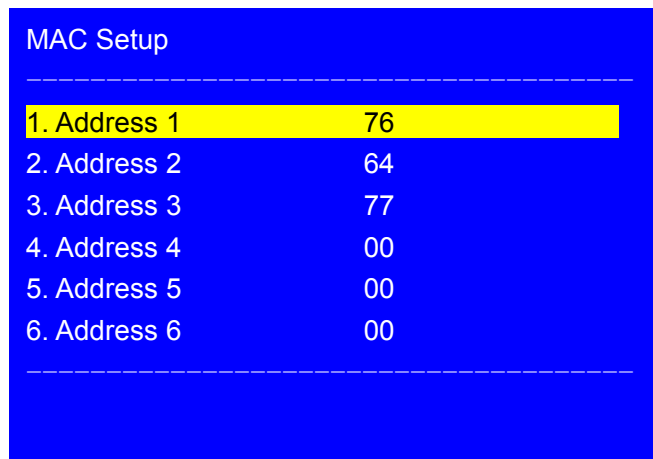

GATE Setup	
1. Address 1	192
2. Address 2	168
3. Address 3	1
4. Address 4	1

Picture 6-4d LCD interface: GATE Setup



MAC Setup	
1. Address 1	76
2. Address 2	64
3. Address 3	77
4. Address 4	00
5. Address 5	00
6. Address 6	00

Picture 6-4e LCD interface: MAC Setup

1-4 option are communication parameter setup menu used to set the communication parameter of LAN port of LVP609. In relative communication parameter setup menu, press  button to enter setup option needed to adjust, rotate  to select parameter, press  button to save, when press  button to exit communication setup, the LCD screen of LVP609 reminder “ IP, MASK, GATE, MAC Change. Please Restart System”, according to reminder please restart LVP609.

## 6.4.2 System advanced setup

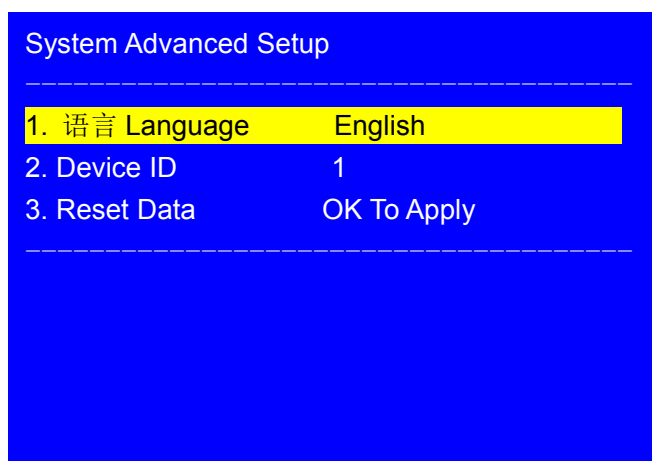

Picture 6-4f LCD interface: System advanced setup

### 6.4.2.1 Language setup

**语言 Language** menu used to set the system language of LVP609. Press button to select system language menu, rotate **Knob** to select **Chinese** or **English**, press **OK** button to save.

### 6.4.2.2 Device serial number setup

**Device ID** menu used to number the serial number of device, when several LVP609 cascade together then use one PC to control them. Setup method:

Press button to select **2.Device ID** menu, rotate **Knob** to modify the serial number, press **OK** button to save.

### 6.4.2.3 Reset data

**Reset date** menu used to reset all date of system, recovery it to be default value. Setup method:

Press button to select **3.Reset Data** menu, press **OK** button, there will be a reminder on LCD "Data will reset", press **OK** button again to reset.

## Chapter 7: Mode instruction

LVP609 serials adopt insert card design method, the quantity of output card depend on requirement to custom-make. The specific mode description as below:

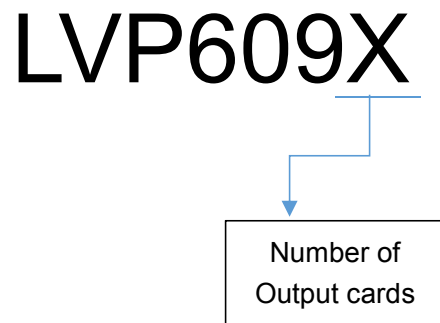

For example LVP6092 means configuring 2 output cards

